

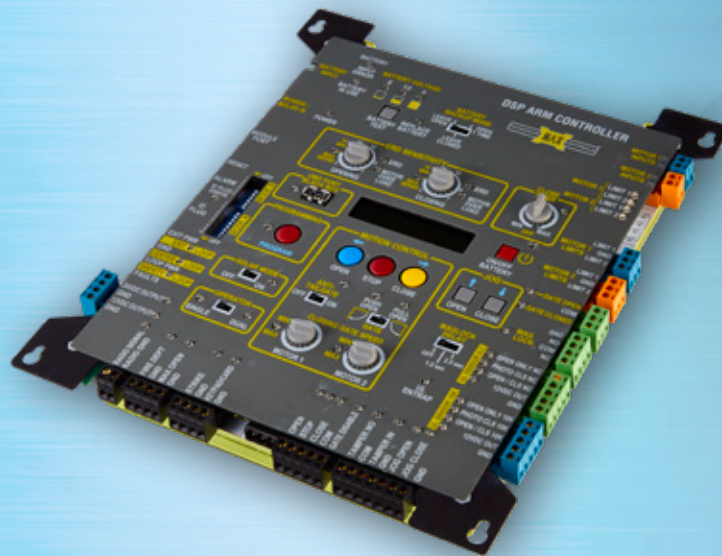

MAX SUPER ARM 2300

Heavy Duty Commercial Linear Gate Operator

Moves heavy gates up to 20'
High traffic high wind
Self-locking, Mag Lock unnecessary
Overload clutch release on 3 ton impact



MAX AC CONTROL BOX

DSP Control

2 Years Warranty
or 100,000 Cycles
whichever comes first



MAX SUPER ARM 2300 FEATURE LIST:

MECHANICAL SPECIFICATIONS

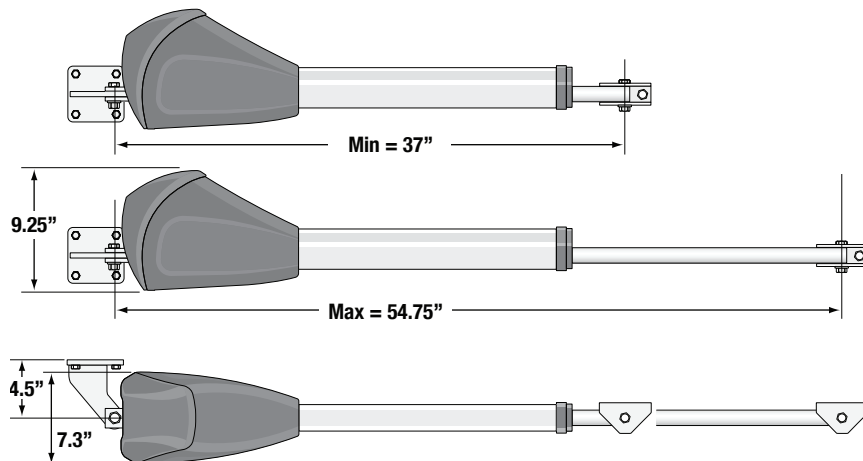

Gate Capacity

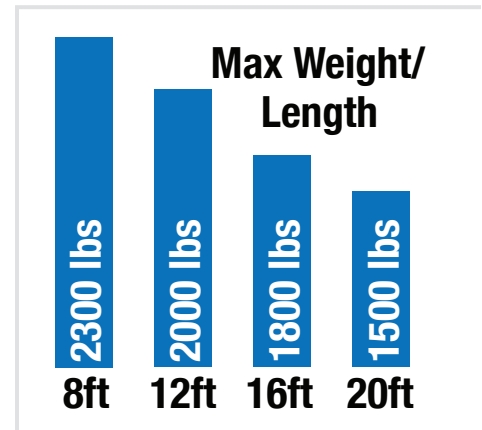

- Shipping weight of Actuator: Super Arm (35 lbs)
- Shipping weight of AC Control Box (38 lbs)
- ✓ The patented brake system allows the operator to retract with extreme force. When the force exceeds 3 tons, the clutch releases upon impact then automatically resets. Causes for clutch release include a vehicle strike while the gate is in motion.
- Stainless steel output shaft
- Direct gear drive (no internal chains, belts, or pulleys)
- Mechanical and electrical gate release functions
- Corrosion protection: gold zinc and powder coated aluminum housing
- High cycles at extreme temperature ranges. No overheating
- Intelligent ramp-up and ramp-down for smooth gate operation

ELECTRICAL SPECIFICATIONS

- 24 Volt DC motor
- Two independently adjustable closing speed controls with 16 positions each
- Switchable 115/230 voltage selection
- ✓ Adaptive DSP motor control for advanced motion control
- Real time performance analyzer and event log (OBD PORT and Black Box)
- Magic Box enables low voltage wiring capabilities for remote power up to 1000 ft
- On-board switch for solar mode enables 5 milliamp idle in sleep mode
- Gold contact input connections and automobile grade connectors
- -4F to 165F (-20C to +74C) operational range including battery backup without a heater

✓ = Unique to Max Super Arm 2300

- Robust lightning protection, up to 20KVolts and 10KAmps on all inputs and outputs (35 channels) including loop detector input connections
- Two selectable 16 position safety obstruction sensors, auto adaptable to gate weight and size, for independent control of open and close cycles
- ✓ Independent closing speeds for primary and secondary
- Dual motor overcurrent safety shut off for additional protection
- Two 7amp hour batteries provides 500 cycles in case of power failure with three modes of battery backup, open once, leave open or leave closed
- On-board three button station
- On-board UL reset button

SECURITY SPECIFICATIONS

- High traffic intuitive loop management system for exceptional security
- Advanced security features with built-in audible and remote alarms
- Magnetic lock control relay outputs with selectable delay times
- Tamper alert relay output triggers “on” if gate is forced open
- Audible alarm if gate is tampered with or ERD is triggered for heightened security
- Steel cover with lock protects against intruders and vandalism
- Gate disable feature disables all inputs with exception of the fire department and Max Open input for increased security
- Built in transaction buffer
- Gate status outputs for gate monitoring
- Key activated jog function for emergency OPEN/CLOSE function
- Advanced anti-tailgate feature prevents unwanted intrusion

SAFETY SPECIFICATIONS

- UL 325/991 compliant Class I, II, III, and IV. CSA approved
- ✓ Vehicle hit protection technology protects the gate operator from collision damage caused by automobile impact, avoiding costly repairs
- Built in advanced entrapment protection and alarm output
- Built in gate-in-motion alarm for industrial applications

✓ = Unique to Max Super Arm 2300

Heavy Duty 1.25" Tubular Stainless Steel

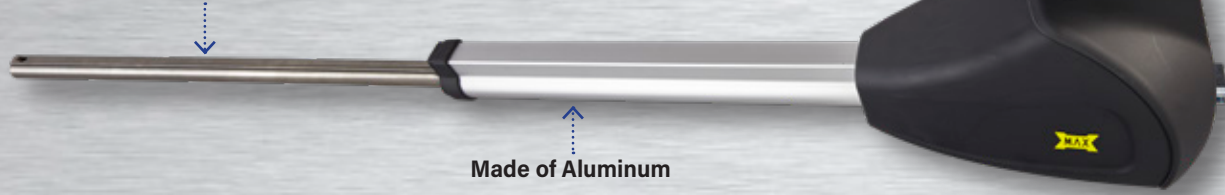

Key switch
mechanical release

The **Max Super Arm 2300** has a solid stainless steel output shaft and key lock for mechanical release. For emergency release unlock the key and lift up the hood. To engage the actuator, push down the hood and lock to resume automatic operation.

SUPER ARM 2300 MECHANICAL RELEASE AND MOUNTING BRACKETS



Front Bracket

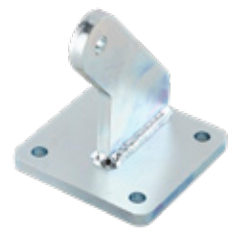

Rear Bracket

The **Max Super Arm 2300** ships with a heavy duty half inch stock rear bracket that is broached and welded. Both brackets front and rear, are silver zinc plated.

VEHICLE HIT PROTECTION

Maximum Controls recognizes swing gates are more prone to vehicular collisions. For this reason the Max Super Arm 2300 will collapse on impact when struck by vehicular traffic. When a vehicle hits a moving gate, to avoid damage to the actuators, then they reset automatically.

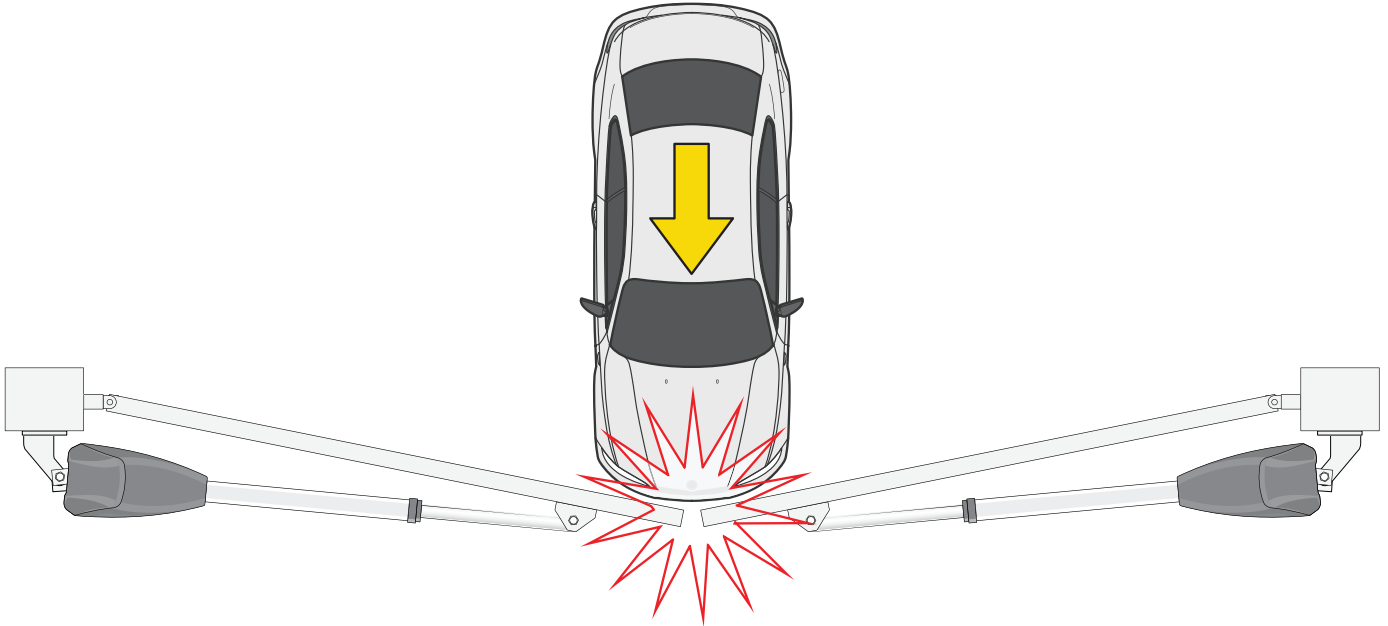

TWO INSTALLATION OPTIONS

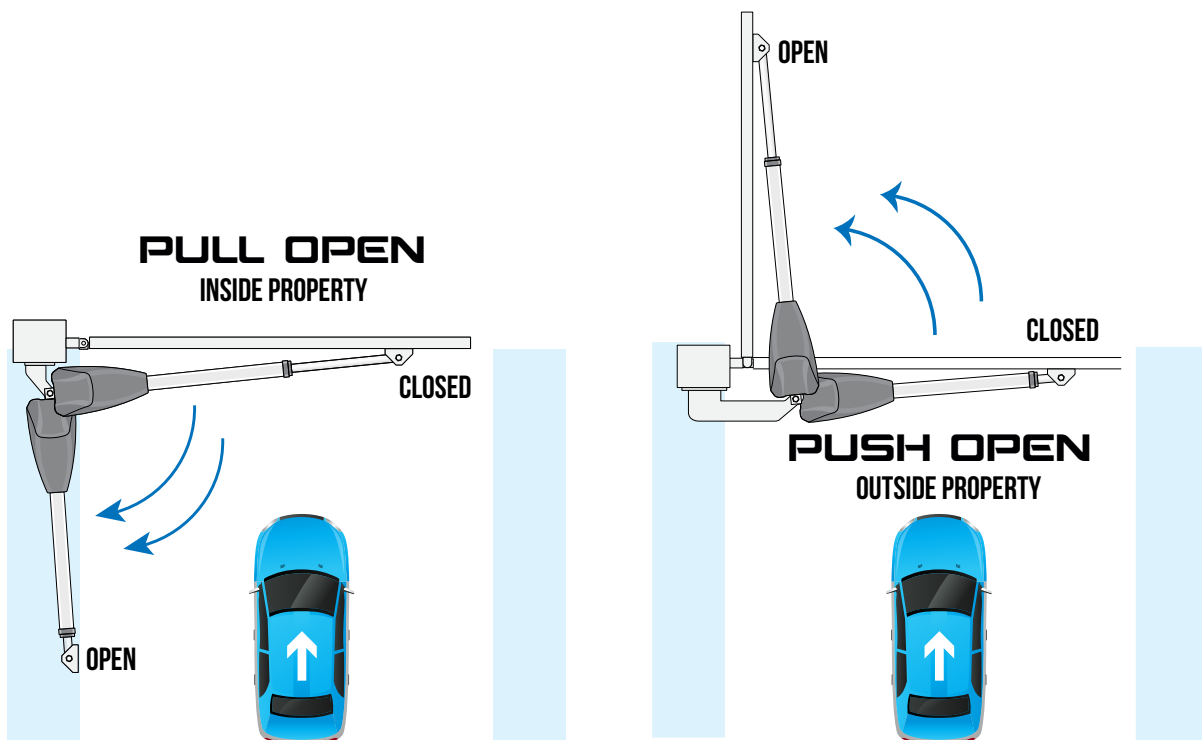

ASYMMETRIC SPEED CONTROL

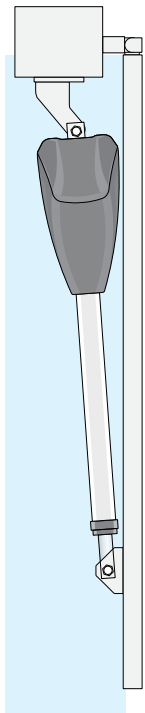

90° OPEN

OPENING ONE 90° AND THE OTHER IS 75°

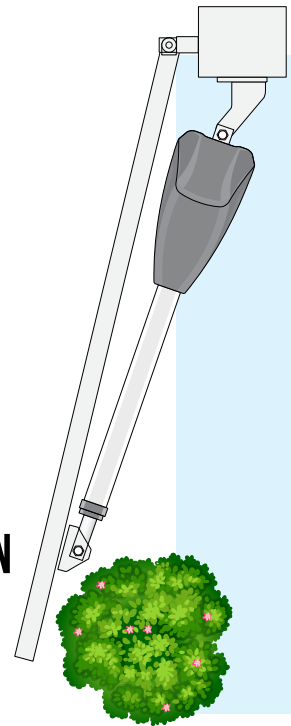

75° OPEN

For asymmetric installations the two independent closing speeds can be adjusted to achieve a smooth closing sync. Whichever gate closes first, slow it down. This enables the installer to visually sync the closing cycle. This feature is unique to Maximum Control's actuators.

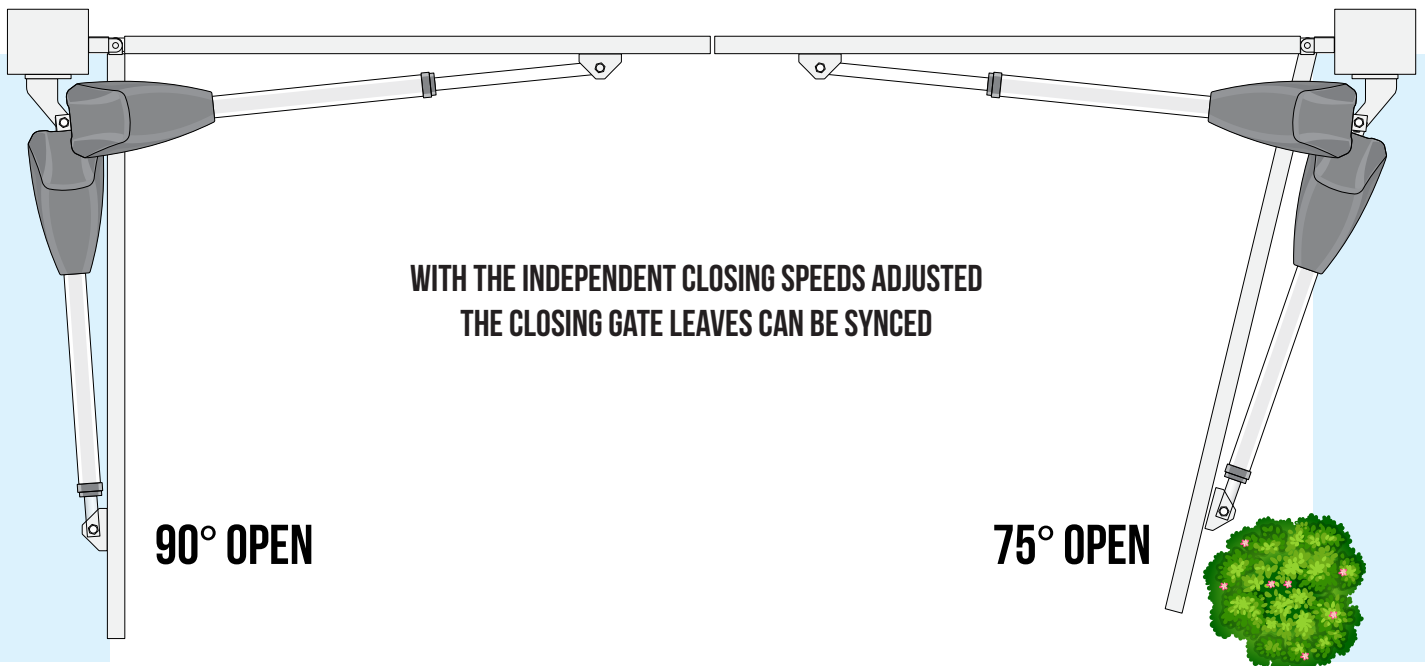

**WITH THE INDEPENDENT CLOSING SPEEDS ADJUSTED
THE CLOSING GATE LEAVES CAN BE SYNCED**

90° OPEN

75° OPEN

AC CONTROL BOX

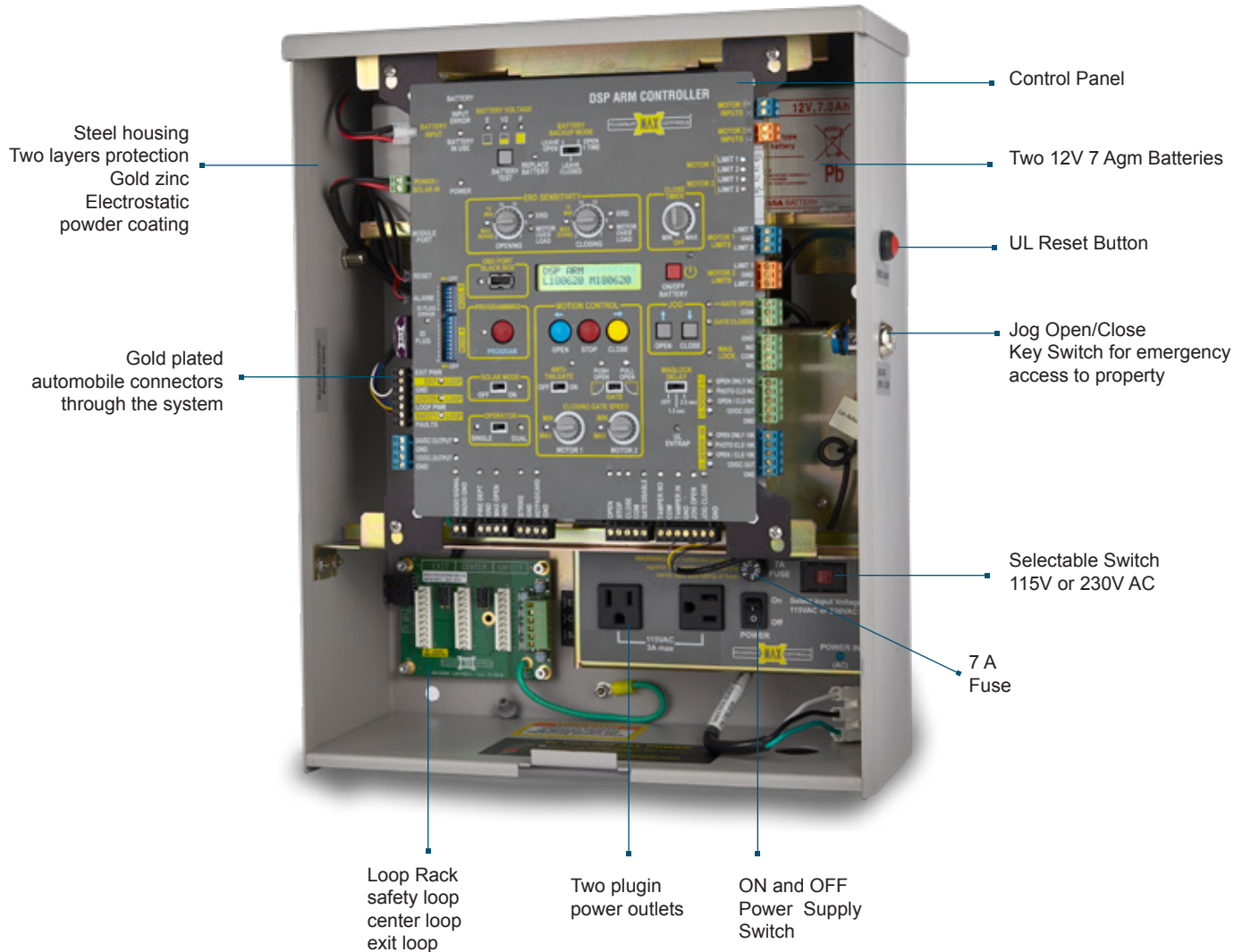

The AC Control Box features rugged metal construction that is gold zinc plated and powder coated. Each AC Control Box comes with an exterior UL reset button, a convenient jog key switch for emergency access or egress, a 10 amp power supply with two 115 VAC accessory outlets, two 7 amp hour batteries conveniently located behind the control panel, a loop rack and much more. A lockable steel cover finishes off this handsome design.

A convenient LCD display keeps you informed. Functional data and error messages are visible when an accessory failure or function is present. This makes troubleshooting and function monitoring a breeze.

These many features can be explored in our downloadable installation manual available on max.us.com

CONTROL FEATURES AND CONNECTIONS

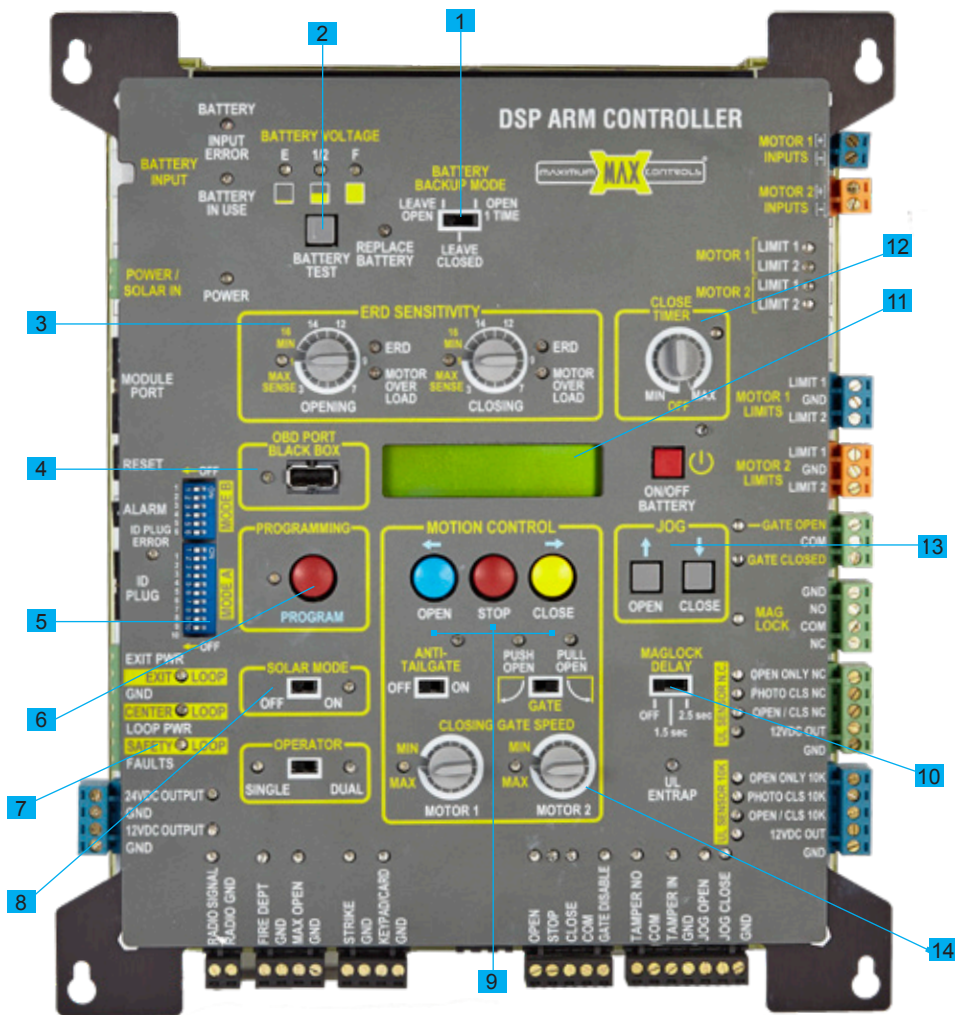

- | | |
|-------------------------------|---------------------------|
| 1. Battery backup mode switch | 8. Solar Mode Application |
| 2. Battery test switch | 9. Motion Control Buttons |
| 3. ERD Sensitivity | 10. Maglock Delay |
| 4. OBD Port | 11. LCD Display |
| 5. DIP Switches | 12. Close Timer Switch |
| 6. Program Button | 13. Jog Open/Close |
| 7. Loop Status | 14. Closing gate speed |

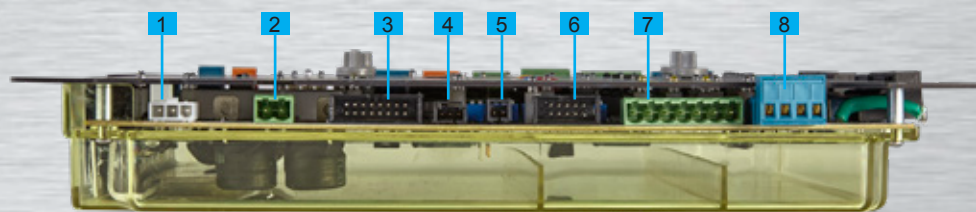

- | | |
|----------------------|-----------------------------------------------|
| 1. Battery Input | 5. UL Alarm |
| 2. Power/Solar Input | 6. ID Plug |
| 3. Module Port | 7. Loop Rack Input |
| 4. Reset | 8. 12vdc & 24vdc limited current power output |

LIGHTNING PROTECTION



The Max Super Arm 2300 offers the most robust lightning protection available in the industry. The Super Arm protects all peripheral inputs, loop inputs, power inputs, relay outputs, and all communication lines (over 35 channels of protection) in $1/1,000,000,000$ of a second. With special emphasis on power supply protection, the Max Super arm 2300 is guaranteed to withstand any lightning hit more than 50 feet away. Truly protected like no other operator in the world.

SUPER ARM 2300 WARRANTY

**2 Years Warranty
or 100,000 Cycles
whichever comes first**



Maximum Controls LLC ("Manufacturer") warrants the original purchaser of this product, for the purpose to which this product is originally installed, that the product is free from defect in materials and/or workmanship for a period of 2 years or 100,000 cycles whichever comes first, with the exception of the batteries which are limited to a 1 year warranty. The performance of this product is dependent on compliance to the instructions, maintenance, operation, and testing clearly outlined in the user manual. Failure to comply completely with those instructions will void this warranty in its entirety. This warranty does not cover damage to the product caused by vandalism, water damage, direct hit lightning strike, or installation errors. This warranty does not include any labor charges that might be needed to troubleshoot, replace, or repair a problem. If, during the limited warranty period, one of the components exhibits a defect in material and/or workmanship, please call 949-699-0220 before dismantling the product. Shipping instructions and an RMA (Return Material Authorization) number will be issued by the factory service center when contacted. Do not send any product in for service without an RMA number. Shipping charges to the factory service center for warranty repairs are the responsibility of the customer. Return standard ground shipping to the customer will be paid for by the Manufacturer for a period of 12 months or 100,000 cycles whichever comes first. For the remainder of the warranty the customer will pay for shipping to and from the factory service center for repair or replacement of any warranty items. These repairs or replacements are made at the sole discretion of the Manufacturer.

ALL IMPLIED WARRANTIES FOR THE PRODUCT, INCLUDING BUT NOT LIMITED TO ANY WARRANTIES OF MERCHANTABILITY AND SUITABILITY FOR A PARTICULAR PURPOSE, ARE LIMITED TO 2 YEARS OR 100,000 CYCLES WHICHEVER COMES FIRST. WITH THE EXCEPTION TO THE BATTERIES WHICH ARE 1 YEAR. NO IMPLIED WARRANTIES WILL EXTEND BEYOND THE WARRANTIES LISTED ABOVE.

Some states do not allow limitations on how long an implied warranty lasts so this limitation might not apply to you. This limited warranty does not cover any problems with or relating to the gate, the gate hardware; including but not limited to hinges, rollers, brackets, entry devices etc. Any service call that determines the cause of a problem to be external to the product could result in a fee. Under no circumstances shall the Manufacturer be liable for consequential, incidental or special damages arising in connection with the use, or inability to use this product. Under no circumstances will the Manufacturer's liability for breach of warranty, breach of contract, negligence or strict liability exceed the cost of the product covered herein. No person is authorized to assume for the Manufacturer any other liability in connection with the sale of this product.



www.Max.US.com

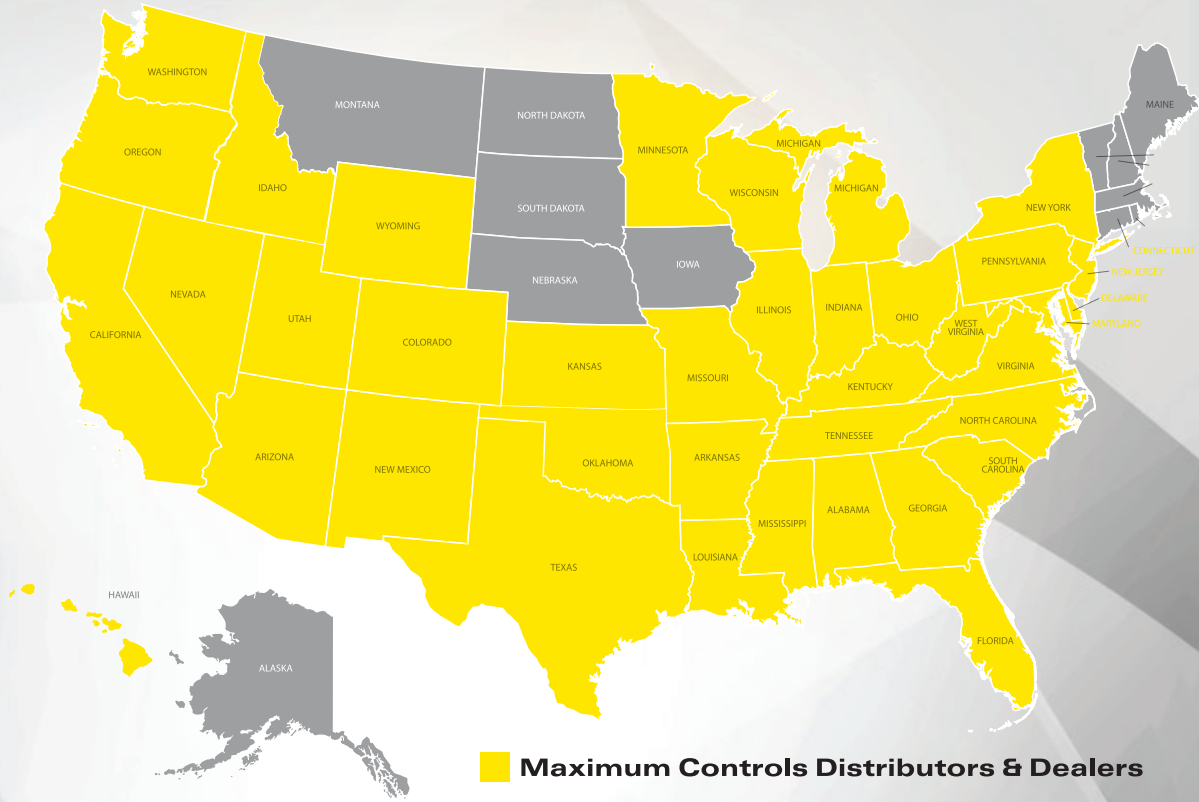

AC CONTROL BOX

DSP Control

MADE IN USA



MAX SUPER ARM 2300

MADE IN GERMANY

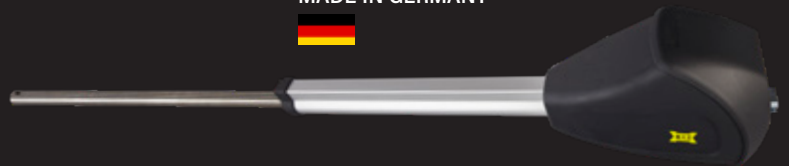

October 5th, 2018

Maximum Controls LLC
949.699.0220

10530 Lawson River Ave.
Fountain Valley CA 92708
USA

Independent Dealer or Distributor